

GENERAL DESCRIPTION

DP8205 uses advanced trench technology to provide excellent $R_{DS(ON)}$, low gate charge and operation with gate voltages as low as 2.5V. This device is suitable for use as a Battery protection or in other Switching application.

PRODUCT SUMMARY

V_{DS}	20 V
I_D (at $V_{GS}=4.5V$)	5.0A
$R_{DS(ON)}$ (at $V_{GS} = 4.5V$)	< 29m Ω
$R_{DS(ON)}$ (at $V_{GS} = 2.5V$)	< 34m Ω

SOT23-6

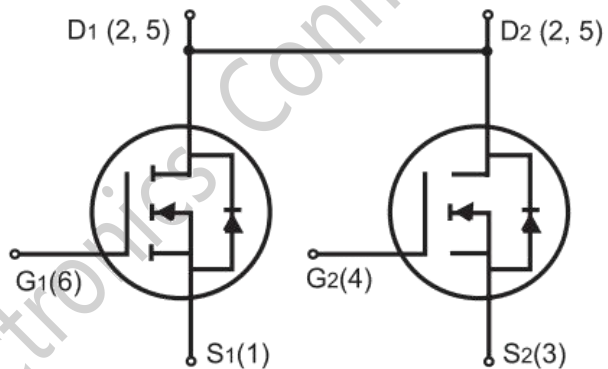
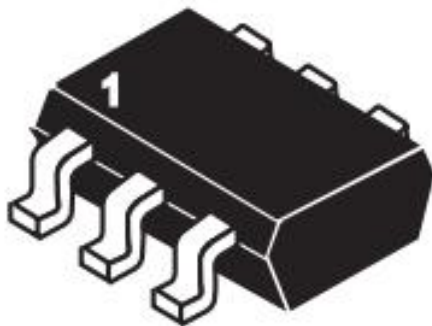

Absolute Maximum Ratings $T_A=25^\circ C$ unless otherwise noted

Parameter	Symbol	Limit	Unit
Drain-Source Voltage	V_{DS}	20	V
Gate-Source Voltage	V_{GS}	± 12	V
Drain Current-Continuous @ $T_J=25^\circ C$	I_D	5	A
Pulsed ^b	I_{DM}	20	A
Drain-Source Diode Forward Current ^a	I_S	2.5	A
Maximum Power Dissipation ^a	P_D	1.25	W
Operating Junction and Storage Temperature Range	T_J, T_{STG}	-55 To 150	$^\circ C$

Thermal Characteristic

Parameter	Symbol	Limit	Unit
Thermal Resistance, Junction-to-Ambient ^a	$R_{\theta JA}$	100	$^\circ C/W$

ELECTRICAL CHARACTERISTICS (TA=25°C unless otherwise noted)

Parameter	Symbol	Condition	Min	Typ ^c	Max	Unit
Off Characteristics						
Drain-Source Breakdown Voltage	BV_{DSS}	$V_{GS}=0V, I_D=250\mu A$	20	-	-	V
Zero Gate Voltage Drain Current	I_{DSS}	$V_{DS}=20V, V_{GS}=0V$	-	-	1	μA
Gate-Body Leakage Current	I_{GSS}	$V_{GS}=\pm 12V, V_{DS}=0V$	-	-	± 100	nA
On Characteristics						
Gate Threshold Voltage	$V_{GS(th)}$	$V_{DS}=V_{GS}, I_D=250\mu A$	0.5	0.7	1.2	V
Drain-Source On-State Resistance	$R_{DS(on)}$	$V_{GS}=4.5V, I_D=4.5A$	14	20	29	m Ω
		$V_{GS}=2.5V, I_D=3.5A$	17	27	34	m Ω
Forward Transconductance	g_{FS}	$V_{DS}=5V, I_D=7A$	-	17.7	-	S
Dynamic Characteristics						
Input Capacitance	C_{iss}	$V_{DS}=8V,$ $V_{GS}=0V,$ $F=1.0MHz$	-	802	-	pF
Output Capacitance	C_{oss}		-	153	-	pF
Reverse Transfer Capacitance	C_{rss}		-	122	-	pF
Switching Characteristics						
Turn-on Delay Time	$t_{d(on)}$	$V_{DD}=10V,$ $I_D=1A$ $V_{GS}=4.5V,$ $R_{GEN}=10\Omega,$ $R_L=10\Omega$	-	18	-	nS
Turn-on Rise Time	t_r		-	5	-	nS
Turn-Off Delay Time	$t_{d(off)}$		-	43.8	-	nS
Turn-Off Fall Time	t_f		-	20	-	nS
Total Gate Charge	Q_g	$V_{DS}=10V,$ $I_D=4A,$ $V_{GS}=4.5V$	-	10.5	-	nC
Gate-Source Charge	Q_{gs}		-	2	-	nC
Gate-Drain Charge	Q_{gd}		-	2.5	-	nC
Drain-Source Diode Characteristics						
Diode Forward Voltage	V_{SD}	$V_{GS}=0V, I_S=1.7A$	-	-	1.2	V

Notes:

- Surface Mounted on FR4 Board, T < 10 sec ;
- Pulse Test: Pulse Width $\leq 300\mu s$, Duty Cycle $\leq 2\%$.
- Guaranteed by Design, not subject to production testing.



TYPICAL ELECTRICAL AND THERMAL CHARACTERISTICS

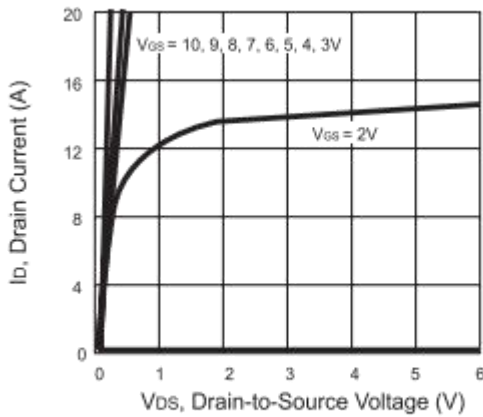

Figure 1. Output Characteristics

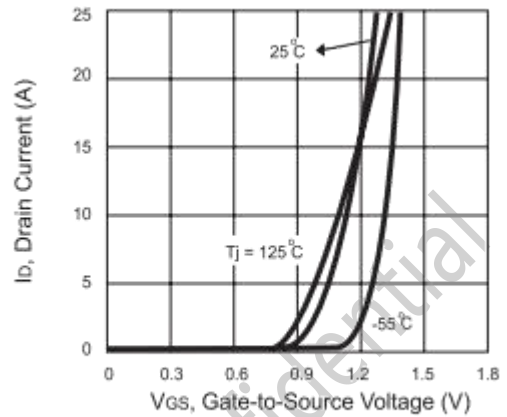

Figure 2. Transfer Characteristics

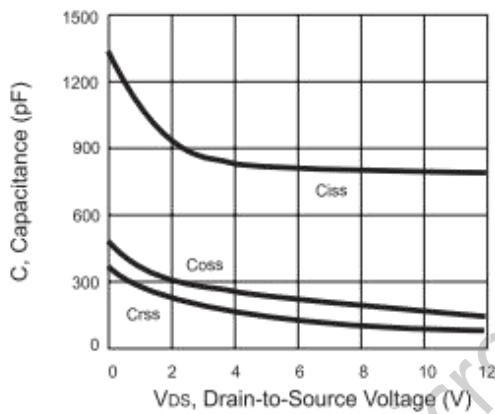

Figure 3. Capacitance

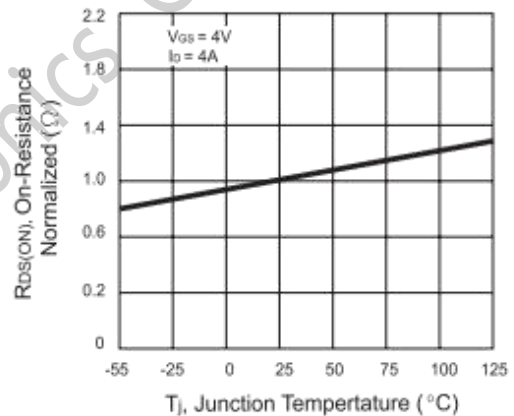

Figure 4. On-Resistance Variation with Temperature

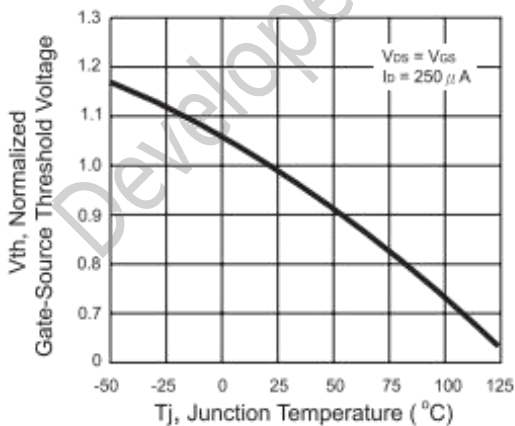

Figure 5. Gate Threshold Variation with Temperature

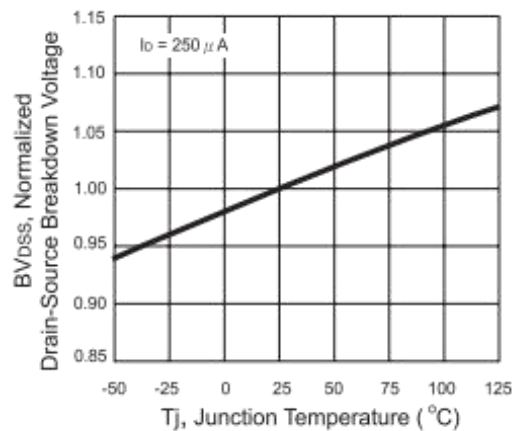

Figure 6. Breakdown Voltage Variation with Temperature

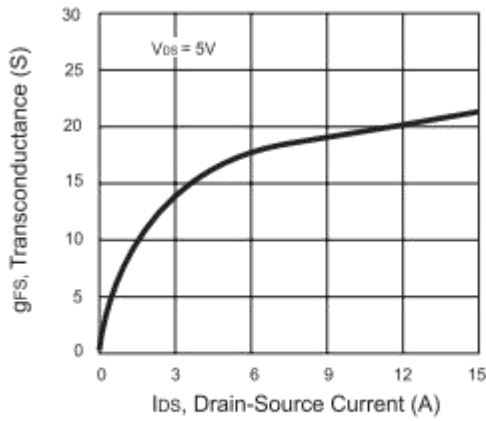

Figure 7. Transconductance Variation with Drain Current

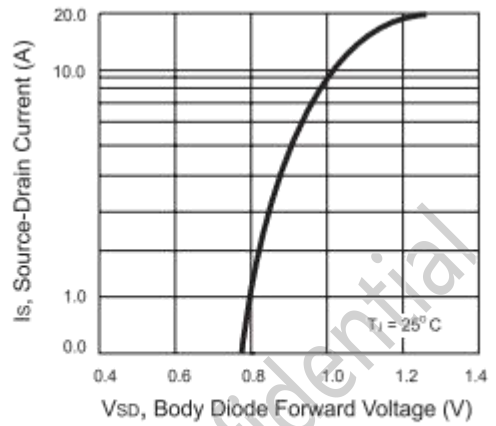

Figure 8. Body Diode Forward Voltage Variation with Source Current

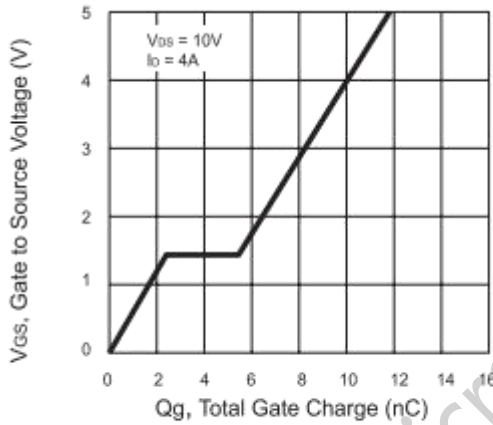

Figure 9. Gate Charge

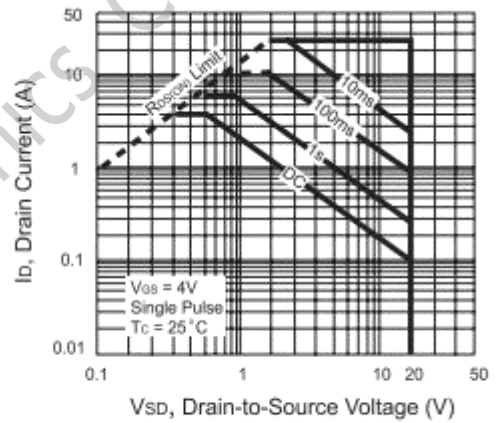

Figure 10. Maximum Safe Operating Area

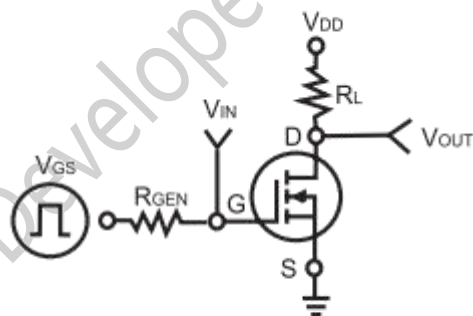

Figure 11. Switching Test Circuit

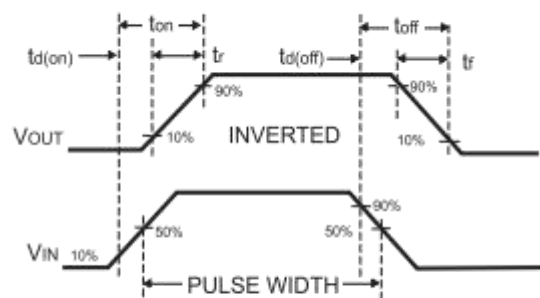

Figure 12. Switching Waveforms

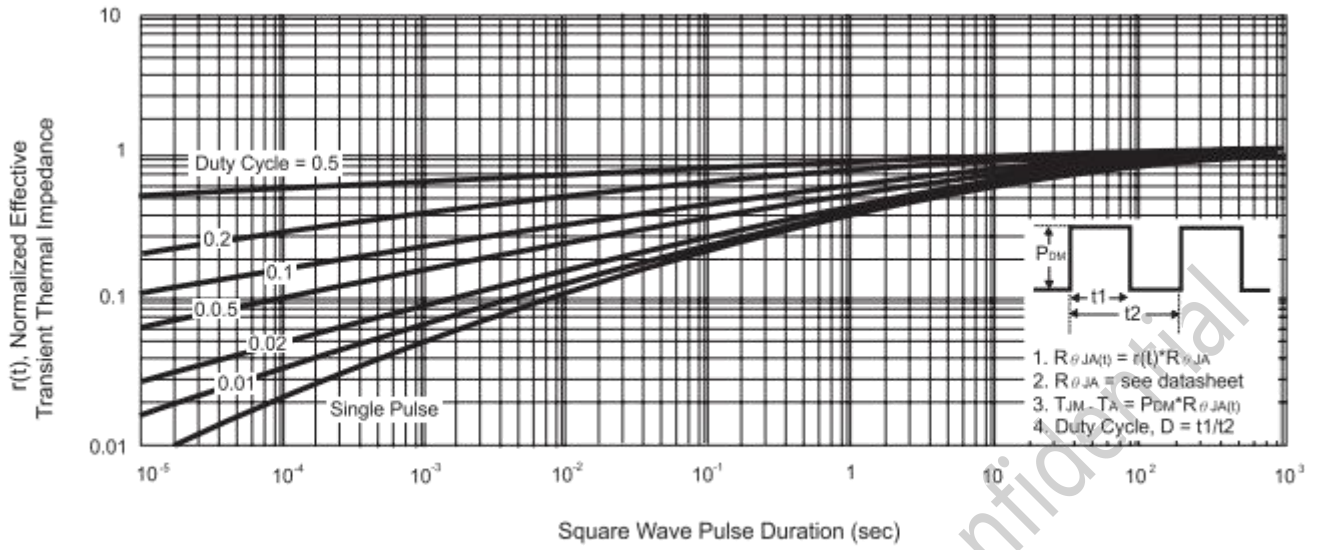
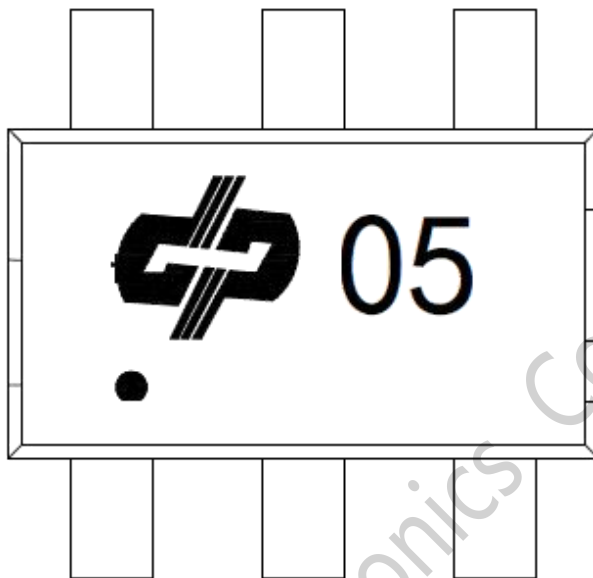

Figure 13. Normalized Thermal Transient Impedance Curve

MARKING DESCRIPTION

SOT23-6



PACKAGE OUTLINE DIMENSIONS

SOT23-6

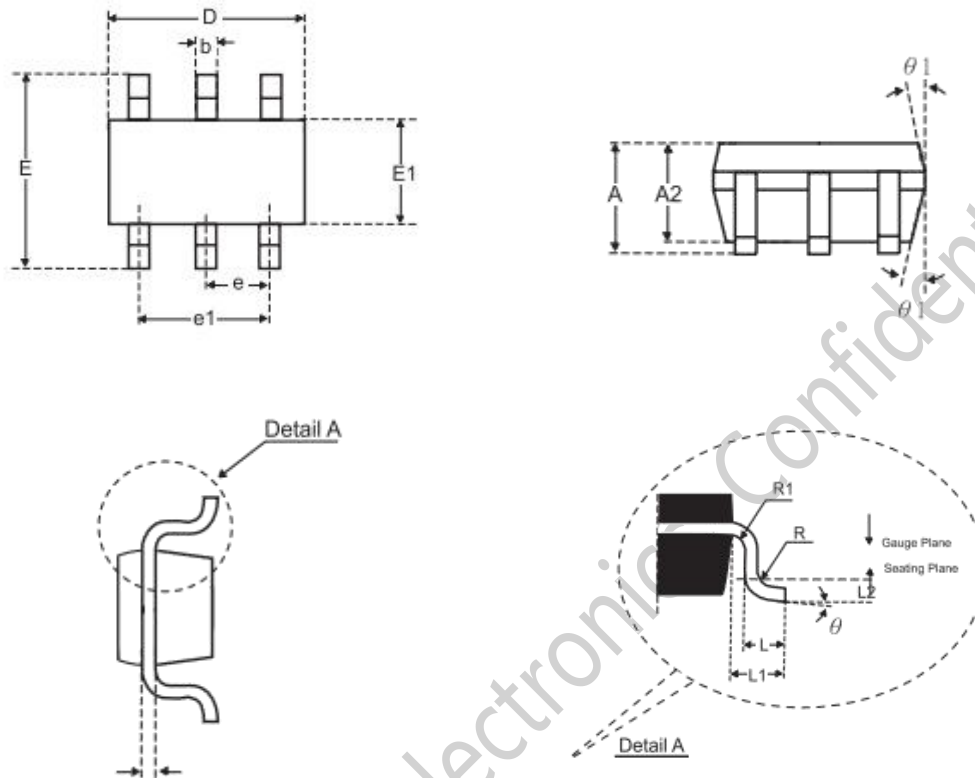

SYMBOLS	MILLIMETERS		
	Min.	Nom.	Max.
A	-	-	1.45
A2	0.90	0.15	1.30
b	0.30	-	0.50
c	0.08	-	0.22
D	2.70	2.90	3.10
E	2.50	2.80	3.10
E1	1.50	1.60	1.70
e	0.95 BSC		
e1	1.90 BSC		
L	0.30	0.45	0.60
L1	0.60 BSC		
L2	0.20 BSC		
R	0.10	-	-
R1	0.10	-	0.25
θ	0°	4°	8°
$\theta1$	0°	10°	15°

TAPE SIZE

SOT23-6

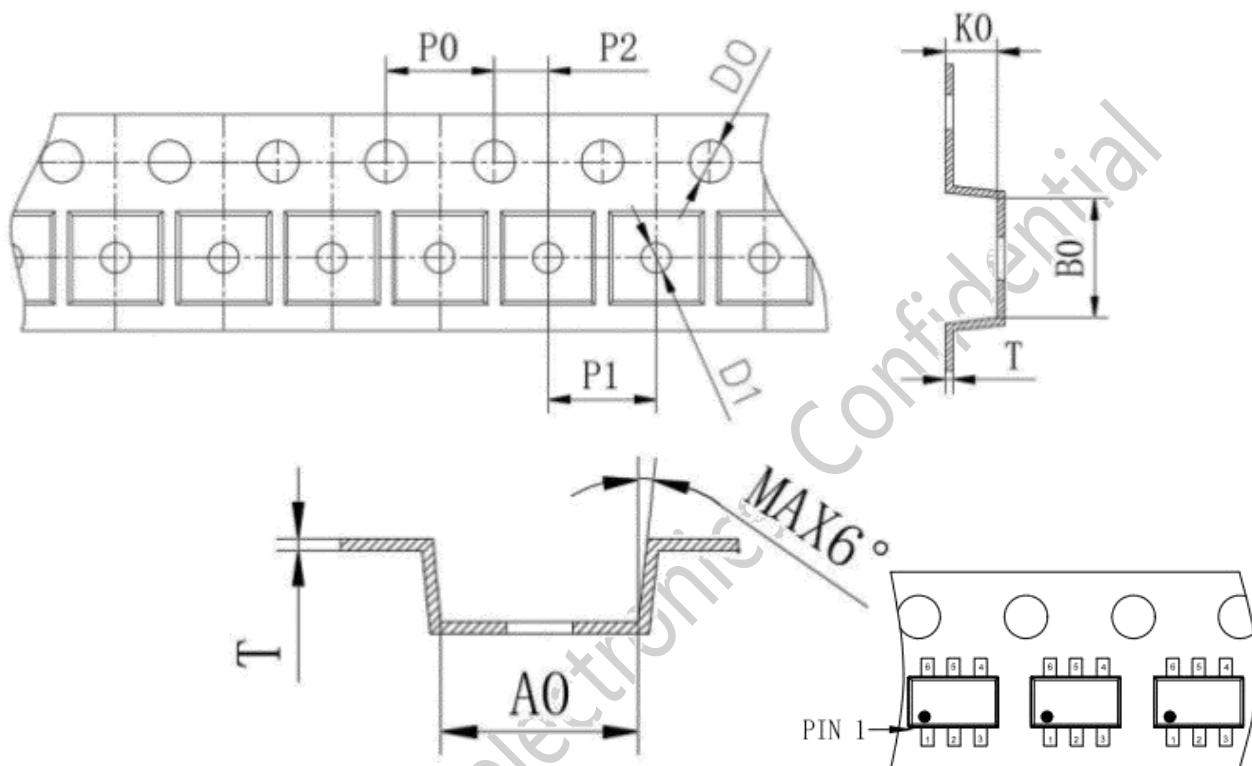

SYMBOL	A0	B0	K0	P0	P1	P2
SPEC	3.23±0.10	3.17±0.10	1.37±0.10	4.00±0.10	4.00±0.10	2.00±0.05
SYMBOL	T	E	F	D0	D1	W
SPEC	0.20±0.05	1.75±0.10	3.50±0.05	1.55±0.05	1.10±0.10	8.00 ^{+0.20} _{-0.10}

OFFICIAL ANNOUNCEMENT

Division I will ensure the accuracy and reliability of the product specification document, but we reserve the right to independently modify the content of the specification document without prior notice to the customer. Before placing an order, customers should contact us to obtain the latest relevant information and verify that this information is complete and up-to-date. All product sales are subject to the sales terms and conditions provided by our company at the time of order confirmation.

Division I will periodically update the content of this document. Actual product parameters may vary due to differences in models or other factors. This document does not serve as any express or implied guarantee or authorization.

The product specification does not include any authorization for the intellectual property owned by our company or any third party. With respect to the information contained in this product specification, we make no explicit or implied warranties, including but not limited to the accuracy of the specification, its fitness for commercial use, suitability for specific purposes, or non-infringement of our company's or any third party's intellectual property. We also do not assume any responsibility for any incidental or consequential losses related to this specification document and its use.

We do not assume any obligations regarding application assistance or customer product design. Customers are responsible for their own use of our company's products and applications. In order to minimize risks associated with customer products and applications, customers should provide thorough design and operational safety validation.

The reproduction, transmission or use of this document or its contents is not permitted without express written authority. Once discovered, the company will pursue its legal responsibility according to law and compensate for all losses caused to the company.

Please note that the product is used within the conditions described in this document, paying particular attention to the absolute maximum rating, operating voltage range, and electrical characteristics. The Company shall not be liable for any damage caused by malfunctions, accidents, etc. caused by the use of the product outside the conditions stated in this document.

Division I has been committed to improving the quality and reliability of products, but all semiconductor products have a certain probability of failure, which may lead to some personal accidents, fire accidents, etc. When designing products, pay full attention to redundancy design and adopt safety indicators, so as to avoid accidents.

When using our chips to produce products, Division I shall not be liable for any patent dispute arising from the use of the chip in the product, the specification of the product, or the country of import, etc., in the event of a patent dispute over the products including the chip.