



# 500mA Low VIN, Ultra-Low Noise and High PSRR Linear Regulator

## FEATURES

- Low Dropout Voltage: 60mV@100mA
- Low Quiescent Current: 50μA(typ.)
- High Ripple Rejection: 80dB@1kHz
- Excellent Line and Load Transient Response
- Operating Voltage Range: 1.8V ~ 6.0V
- Output Voltage Range: 1.0V ~ 5.0V
- High Accuracy: ±2% (Typ.)
- Low Output Noise: 40μVRMS (10Hz~100kHz)
- 500mA Output Current
- Low Dropout Voltage:
  - ◆ 60mV (TYP) at 100mA when VOUT = 1.8V (SOT23-5)
- Built-in Current Limiter, Thermal shutdown and Short-Circuit Protection
- TTL- Logic-Controlled Shutdown Input
- With Output Automatic Discharge
- Available in Green XTDFN-1×1-4L and SOT23-5 Packages

## APPLICATIONS

- Portable Electronic Devices
- Smoke Detectors
- IP Cameras
- Wireless LAN Devices
- Battery-Powered Equipment
- Smartphones and Tablets
- Digital Cameras and Audio Devices

## TYPICAL APPLICATION CIRCUIT

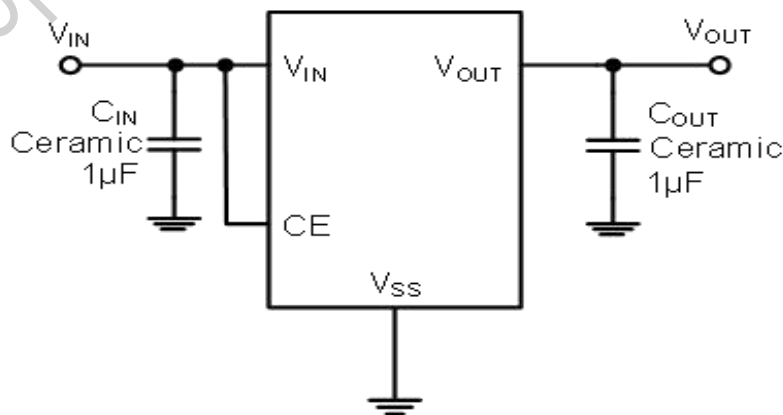

## DESCRIPTIONS

The DP31302 series are a group of positive voltage regulators manufactured by CMOS technologies with high ripple rejection, ultra-low noise, low power consumption and low dropout voltage, which can prolong battery life in portable electronics.

The DP31302 series work with low-ESR ceramic capacitors, reducing the amount of board space necessary for power applications.

The DP31302 series consume less than 0.1 μA in shutdown mode and have fast turn-on time less than 50 μS. The series are very suitable for the battery-powered equipment, such as RF applications and other systems requiring a quiet voltage source.

## ORDERING INFORMATION

Part Number	Description
SOT23-5	Pb free in T&R, 3000 Pcs/Reel
XTDFN-1×1-4L	Pb free in T&R, 10000 Pcs/Reel

## PRODUCT DESCRIPTION

### ➤ Pin Arrangement

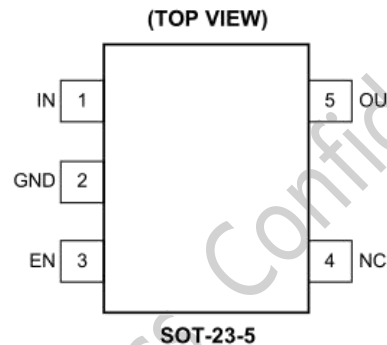
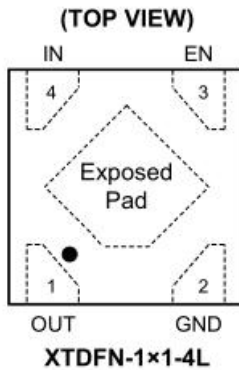

### ➤ Pin Configuration

SOT23-5	XTDFN-1x1-4L	Pin Name	Description
1	4	IN	Input Supply Voltage Pin. It is recommended to use a 1 $\mu$ F or larger ceramic capacitor from IN pin to ground to get good power supply decoupling. This ceramic capacitor should be placed as close as possible to IN pin.
2	2	GND	Ground.
3	3	EN	Enable Pin. Drive EN high to turn on the regulator. Drive EN low to turn off the regulator. This pin must be pulled high by an external resistor connected to IN pin if EN pin is not used.
4	-	NC	No Connection.
5	1	OUT	Regulator Output Pin. It is recommended to use a ceramic capacitor with effective capacitance in the range of 1 $\mu$ F to 10 $\mu$ F to ensure stability. This ceramic capacitor should be placed as close as possible to OUT pin.
-	Exposed Pad	GND	Exposed Pad. Connect it to a large ground plane to maximize thermal performance.

## ➤ Marking Information

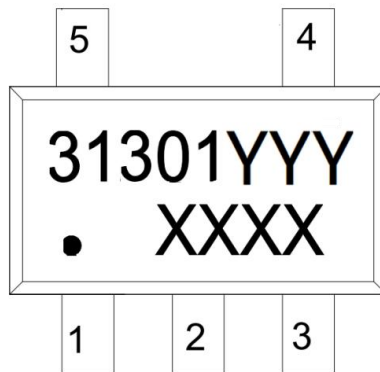

DP31302 for product name:

YYY refers to the following table description, represents different packaging and special output voltage

XXXX The first X represents the last year, 2020 is 0; The second X represents the month, in A-L 12 letters; The third and fourth X on behalf of the date, 01-31 said;

Marking	Model	VOUT Voltage	PACKAGE
10	DP31302-10ATD	1.0V	XTDFN-1×1-4L
105	DP31302-105ATD	1.05V	XTDFN-1×1-4L
11	DP31302-11ATD	1.1V	XTDFN-1×1-4L
12	DP31302-12ATD	1.2V	XTDFN-1×1-4L
15	DP31302-15ATD	1.5V	XTDFN-1×1-4L
18	DP31302-18ATD	1.8V	XTDFN-1×1-4L
25	DP31302-25ATD	2.5V	XTDFN-1×1-4L
28	DP31302-28ATD	2.8V	XTDFN-1×1-4L
30	DP31302-30ATD	3.0V	XTDFN-1×1-4L
33	DP31302-33ATD	3.3V	XTDFN-1×1-4L



36	DP31302-36ATD	3.6V	XTDFN-1×1-4L
42	DP31302-42ATD	4.2V	XTDFN-1×1-4L
31302-10	DP31302-10AST	1.0V	SOT23-5
31302105	DP31302-105AST	1.05V	SOT23-5
31302-11	DP31302-11AST	1.1V	SOT23-5
31302-12	DP31302-12AST	1.2V	SOT23-5
31302-15	DP31302-15AST	1.5V	SOT23-5
31302-18	DP31302-18AST	1.8V	SOT23-5
31302-25	DP31302-25AST	2.5V	SOT23-5
31302-28	DP31302-28AST	2.8V	SOT23-5
31302-30	DP31302-30AST	3.0V	SOT23-5
31302-33	DP31302-33AST	3.3V	SOT23-5
31302-36	DP31302-36AST	3.6V	SOT23-5
31302-4.2	DP31302-42AST	4.2V	SOT23-5

## ➤ Absolute Maximum Ratings

Over operating temperature range (unless otherwise noted)(1)

PARAMETER	Min	Max	Unit
VIN Voltage <sup>(1)</sup>	-0.3	7	V
EN Voltage	-0.3	7	V
VOUT Voltage <sup>(2)</sup>	-0.3	VIN+0.3	V
Output Current	-	500	mA
Power Dissipation	-	250	mW
Operating free air temperature range	-40	85	°C
Operating junction temperature,TJ	-40	150	°C
Storage temperature, Tstg	-65	150	°C
Lead Temperature (Soldering, 10sec.)	-	260	°C

Note:(1)Stresses beyond those listed under absolute maximum ratings may cause permanent damage to the device. Functional operation of the device at these or any other conditions beyond those indicated under recommended operating conditions is not implied. Exposure to absolute – maximum – rated conditions for extended periods may affect device reliability.

(2) All voltage values are with respect to network ground terminal

## ➤ Recommended Operating Conditions

PARAMETER	Min	Max	Unit
VIN Voltage(VIN)	1.8	6	V
VOUT Voltage(VOU <sub>T</sub> )	1	5	V
Output current(I <sub>OUT</sub> )	-	500	mA
TJ	-40	125	°C

Note : (1)All limits specified at room temperature (TA = 25°C) unless otherwise specified. All room temperature limits are 100% production tested. All limits at temperature extremes are ensured through correlation using standard Statistical Quality Control (SQC) methods. All limits are used to calculate Average Outgoing Quality Level (AOQL).

## ➤ ESD Ratings

PARAMETER	Description	Value	Unit
HBM	Human-body model (HBM), per ANSI/ESDA/JEDEC JS-001(1)	±2000	V
CDM	Charged-device model (CDM), per JEDEC specification JESD22-C101(2)	±200	V

Note : (1) JEDEC document JEP155 states that 500-V HBM allows safe manufacturing with a standard ESD control process.

(2) JEDEC document JEP157 states that 250-V CDM allows safe manufacturing with a standard ESD control process.

## ➤ Thermal Information

THERMAL METRIC	Description	SOT23-5	XTDFN-1 ×1-4L	Unit
$R_{\theta JA}$	Junction-to-ambient thermal resistance <sup>(1)(2)</sup>	191.6	166.1	°C/W
$R_{\theta JC(top)}$	Junction-to-case (top) thermal resistance	141.4	103.6	°C/W
$R_{\theta JB}$	Junction-to-board(Bottom) thermal resistance	44.5	110.6	°C/W
$\psi_{JT}$	Junction-to-top characterization parameter	34.5	3.0	°C/W
$\psi_{JB}$	Junction-to-board characterization parameter	43.9	103.3	°C/W

Note (1): The package thermal impedance is calculated in accordance to JESD 51-7.

Note (2): Thermal Resistances were simulated on a 4-layer, JEDEC board



### BLOCK DIAGRAM

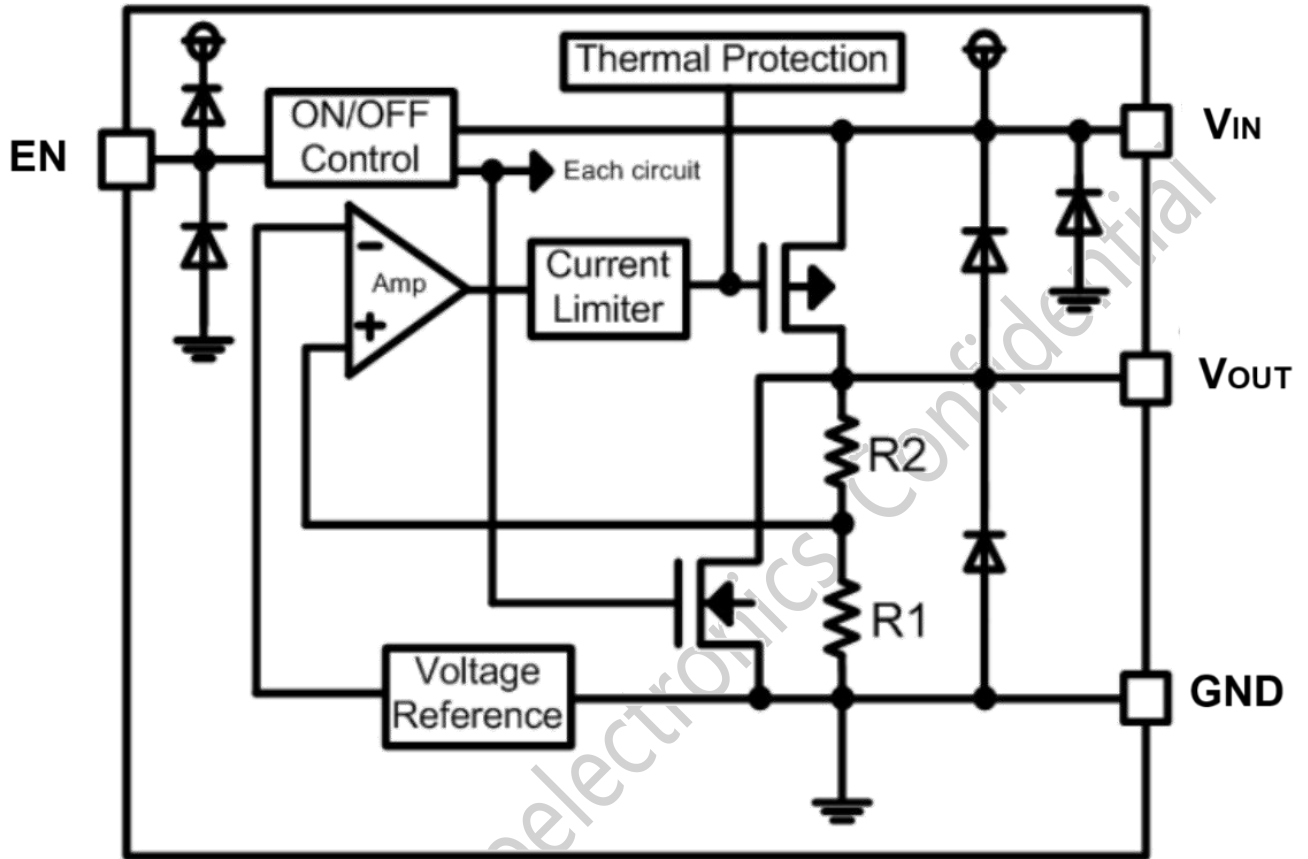

Future 1 Functional Block Diagram

## ELECTRICAL CHARACTERISTICS

$V_{IN}=V_{OUT}+1V$ ,  $C_{IN}=C_{OUT}=1\mu F$ ,  $T_A=25^\circ C$ , unless otherwise specified

Parameter	Symbol	Test Conditions	Min	Typ	Max	Units
Input Voltage	$V_{IN}$	-	1.8	-	6	V
Output Voltage	$V_{OUT}$	$I_{OUT}=1mA$	$V_{OUT}^*$ 0.98	-	$V_{OUT}^*$ 1.02	V
Supply Current	$I_Q$	$I_{OUT}=0mA$		50	80	$\mu A$
Standby Current	$I_{SHDN}$	$V_{EN}=0V$		0.1	1	$\mu A$
Output Current	$I_{OUT}$	-		500		mA
Dropout Voltage	$V_{DROP}$	$I_{OUT}=60mA$ $V_{OUT}=2.8V$		30		mV
		$I_{OUT}=100mA$ $V_{OUT}=2.8V$		50		mV
		$I_{OUT}=200mA$ $V_{OUT}=2.8V$		100		mV
		$I_{OUT}=300mA$ $V_{OUT}=2.8V$		150		mV
		$I_{OUT}=400mA$ $V_{OUT}=2.8V$		190		mV
		$I_{OUT}=500mA$ $V_{OUT}=2.8V$		240		mV
Load Regulation	$\Delta V_{OUT}$	$V_{IN}=V_{OUT}+1V$ , $1mA \leq I_{OUT} \leq 500mA$		10		mV
Line Regulation	$\frac{\Delta V_{OUT}}{V_{OUT} \times \Delta V_{IN}}$	$I_{OUT}=100mA$ $V_{OUT}+1V \leq V_{IN} \leq 6V$		0.01	0.2	%/V
	$\frac{\Delta V_{OUT}}{\Delta T \times V_{OUT}}$	$I_{OUT}=10mA$ $-40 \leq T \leq +85^\circ C$		50		ppm
Short Current	$I_{short}$	$V_{OUT}=0V$		130		mA
Power Supply Rejection Rate	PSRR	$F=100HZ$ $I_{OUT}=50mA$		75		dB
		$F=1KHZ$ $I_{OUT}=50mA$		80		
		$F=10KHZ$ $I_{OUT}=50mA$		70		
EN Rising Threshold	$V_{EN(R)}$	$1.8V \leq V_{IN} \leq 5.5V$	1.5			V
EN Falling Threshold	$V_{EN(F)}$	$1.8V \leq V_{IN} \leq 5.5V$			0.3	V
Over-Temperature Protection	$T_{SD}$			160		$^\circ C$
Over-Temperature Protection hysteresis	$\Delta T_{SD}$			20		$^\circ C$
CO <sub>UT</sub> Auto-Discharge Resistance	$R_{DISCHRG}$	$V_{IN}=5V$ , $V_{OUT}=3.0V$ , $V_{CE}=V_{SS}$		100		$\Omega$



## TYPICAL CHARACTERISTICS

T<sub>J</sub> = +25°C, V<sub>IN</sub> = (V<sub>OUT(NOM)</sub> + 1V) (whichever is greater), V<sub>EN</sub> = V<sub>IN</sub>, C<sub>IN</sub> = C<sub>OUT</sub> = 1μF, unless otherwise noted.

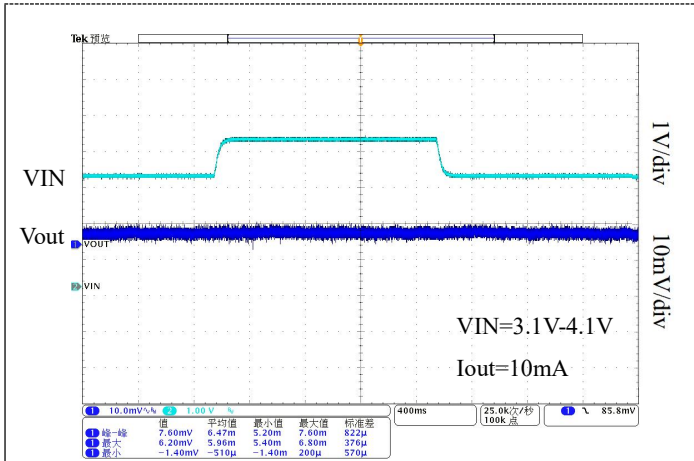

Figure1 Vout=2.8V Line Transient Response

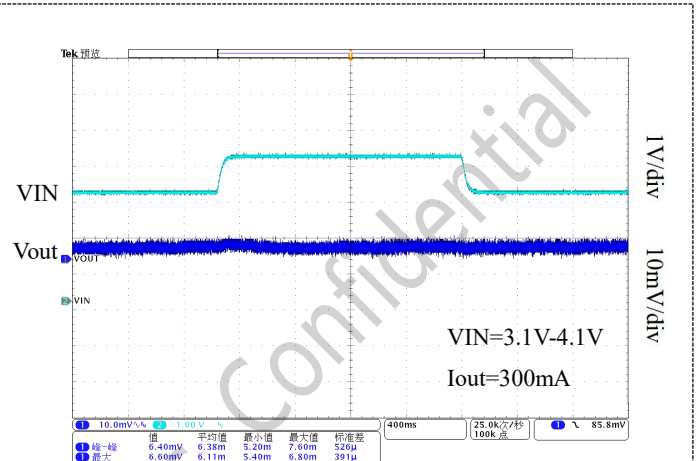

Figure2 VOUT=2.8V Line Transient Response

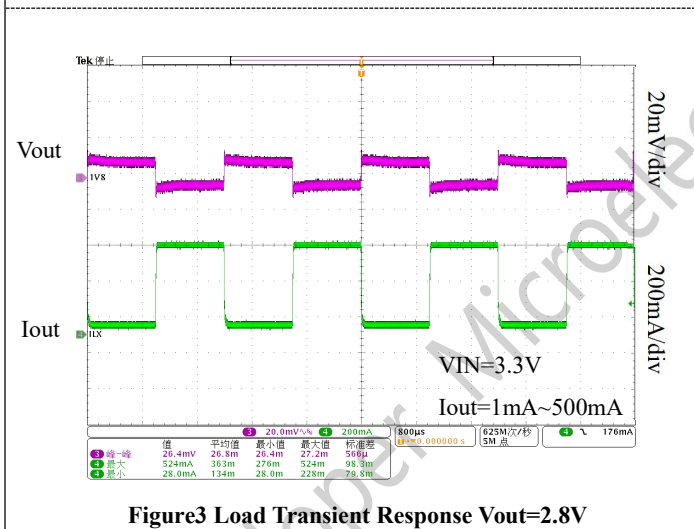

Figure3 Load Transient Response Vout=2.8V

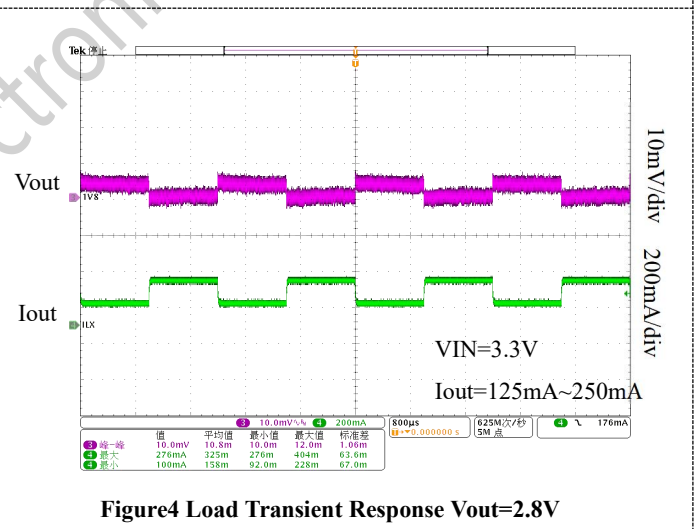

Figure4 Load Transient Response Vout=2.8V

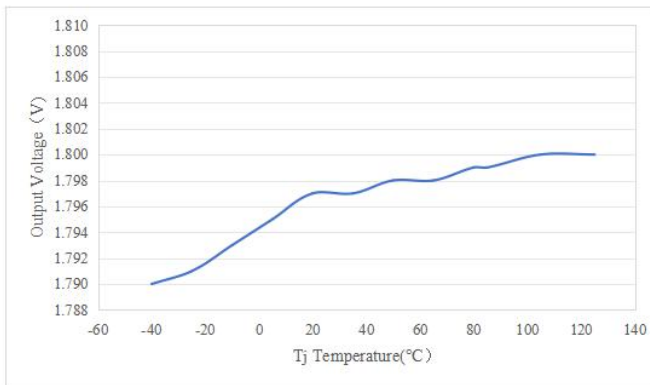

Figure5 Output Voltage vs. Temperature

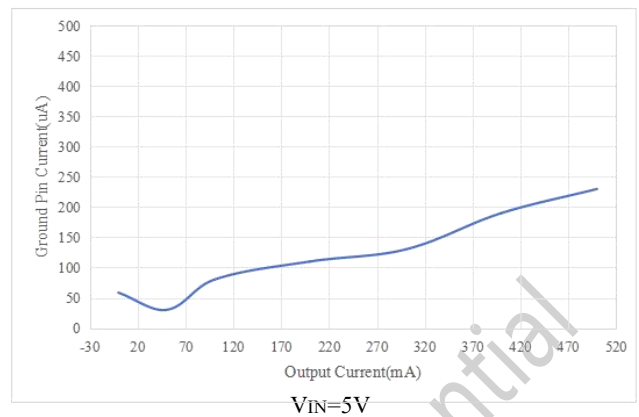

Figure6 Output Current vs. Ground Current

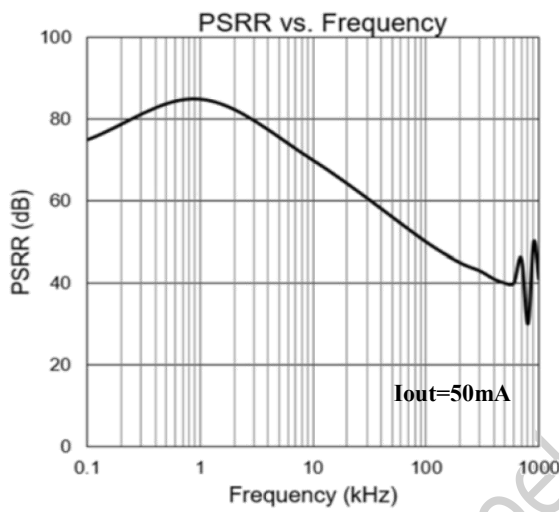

Figure7 Power Supply Rejection Ratio vs. Frequency

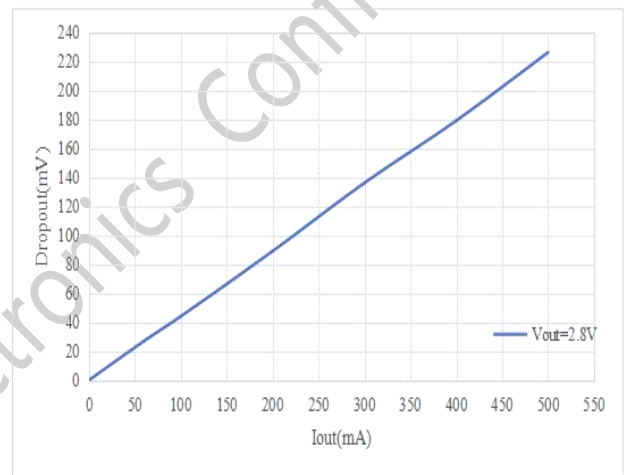

Figure8 Dropout vs. Output Current

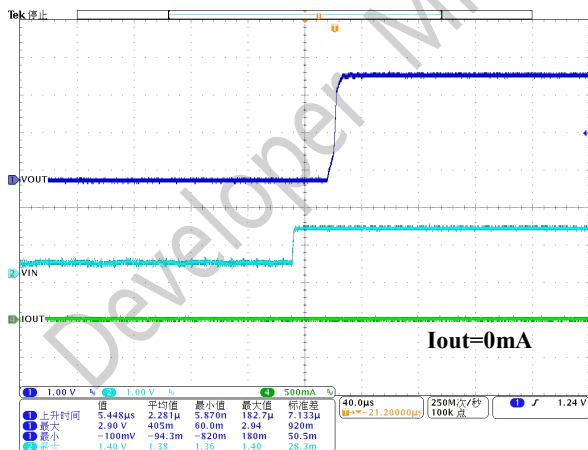

Figure9 EN Start Up with Load

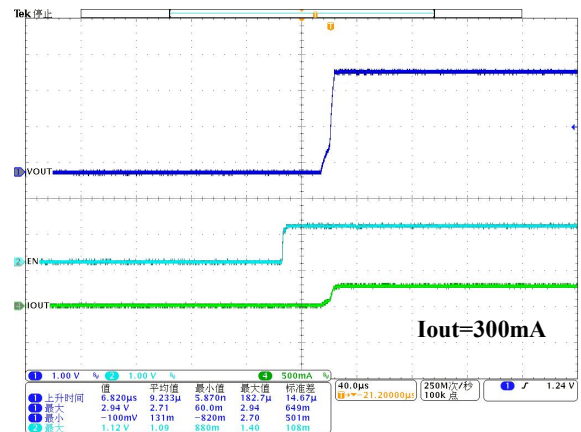
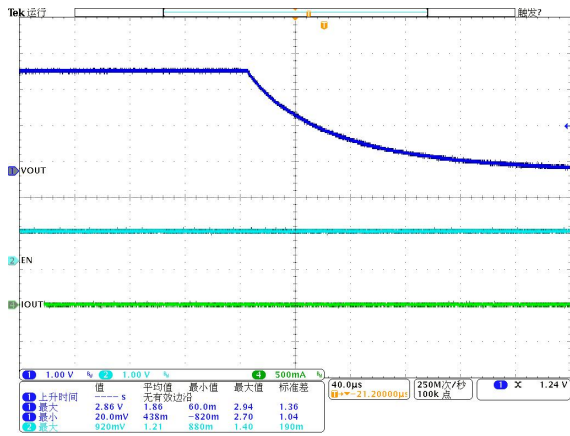
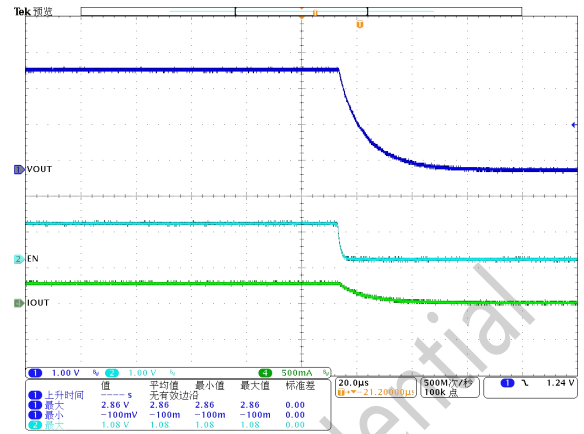

Figure10 EN Start Up with Load



$I_{out}=0.01A$

Figure11 EN Start Down with Load



$I_{out}=0.3A$

Figure12 EN Start Down with Load

## FUNCTIONS DESCRIPTION

- **Feature Description**

The DP31302 series are a group of positive voltage regulators manufactured by CMOS technologies with high ripple rejection, ultra-low noise, low power consumption and low dropout voltage, which can prolong battery life in portable electronics.

The DP31302 series work with low-ESR ceramic capacitors, reducing the amount of board space necessary for power applications.

The DP31302 series consume less than 0.1 $\mu$ A in shutdown mode and have fast turn-on time less than 50 $\mu$ S. The series are very suitable for the battery-powered equipment, such as RF applications and other systems requiring a quiet voltage source..

- **Thermal Shutdown**

The internal thermal-shutdown circuitry forces the device to stop switching if the junction temperature exceeds 160 ° C typically. Once the junction temperature falls below the falling threshold, the device returns to normal operation automatically.

- **Output Current Limit and Short-Circuit**

### Protection

When overload events happen, the output current is internally limited to 700mA (TYP). When the OUT pin is shorted to ground, the short-circuit protection will limit the output current to 130mA (TYP).

## APPLICATION INFORMATION

The DP31302 is a low VIN, ultra-low noise and low dropout LDO and provides 500mA output current.

These features make the device a reliable solution to solve many challenging problems in the generation of clean and accurate power supply.

The high performance also makes the DP31302 useful in a variety of applications. The DP31302 provides the protection functions for output overload, output short-circuit condition and overheating.

The DP31302 provides an EN pin as an external chip enable control to enable/disable the device. When the regulator is in shutdown state, the shutdown current consumes as low as 0.03 $\mu$ A (TYP).

### ● Input capacitors selection

The input decoupling capacitor should be placed as close as possible to the IN pin to ensure the device stability. 1 $\mu$ F or larger X7R or X5R ceramic capacitor is selected to get good dynamic performance. When VIN is required to provide large current instantaneously, a large effective input capacitor is required. Multiple input capacitors can limit the input tracking inductance. Adding more input capacitors is available to restrict the ringing and to keep it below the device absolute maximum ratings.

### ● Output capacitors selection

The output capacitor should be placed as close as possible to the OUT pin. 1 $\mu$ F or larger X7R or X5R ceramic capacitor is selected to get good dynamic performance. The minimum effective capacitance of COUT that DP31302 can remain stable is 1 $\mu$ F. For ceramic capacitor, temperature, DC bias and package size will change the effective capacitance, so enough margin of COUT must be considered in design. Additionally, COUT with larger capacitance and lower ESR will help increase the high frequency PSRR and improve the load transient response.

### ● Enable Operation

The EN pin of the DP31302 is used to enable/disable its device and to deactivate/activate the output automatic discharge function. When the EN pin voltage is lower than 0.3V, the device is in shutdown state. There is no current flowing from IN to OUT pins. In this state, the automatic discharge transistor is active to discharge the output voltage through a 100 $\Omega$  (TYP) resistor.

When the EN pin voltage is higher than 0.7V, the device is in active state. The output voltage is regulated to the expected value and the automatic discharge transistor is turned off.

### ● PCB Layout

PCB layout is a critical portion of good power supply design. The following guidelines will help users design a PCB with the best power conversion efficiency, thermal performance

**1.** The input bypass capacitor C5 and C11 must be placed as close as possible to the VIN pin and ground. Grounding for both the input and output capacitors should consist of localized top side planes that connect to the GND pin and PAD. It is a good practice

to place a ceramic cap near the VIN pin to reduce the high frequency injection current.

**2.** The output capacitor, COUT should be placed close to the junction of Vout Pin.

**3.** The ground connection for C5, C11 and C10, C12 should be as small as possible and connect to system ground plane at only one spot (preferably at the COUT ground point ) to minimize injecting noise into system ground plane.

**4.** Large GND Copper Pour near IC is recommended to minimize the heat of IC.

### ● Layout Example:

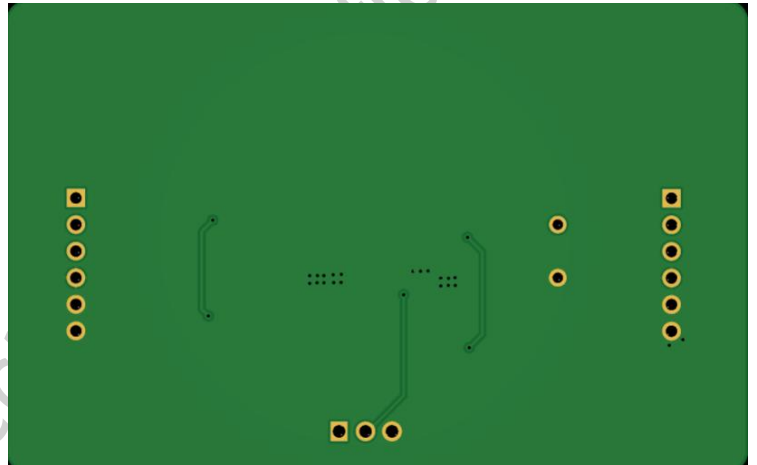
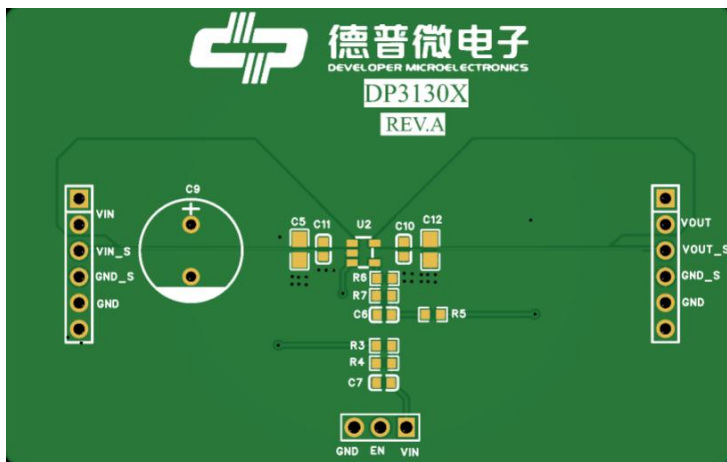

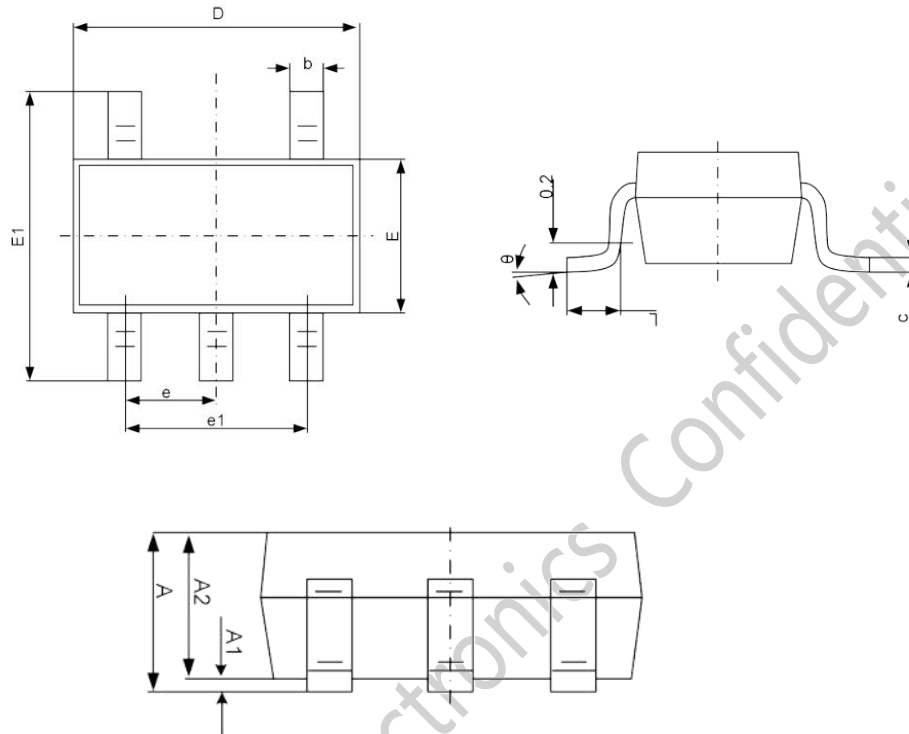
**PACKAGE DIMENSION**
**SOT23-5**

Symbol	Dimensions in Millimeters	
	Min	Max
A	-	1.350
A1	0.000	0.150
A2	1.000	1.200
b	0.300	0.500
c	0.100	0.220
D	2.820	3.020
E	1.500	1.700
E1	2.600	3.000
e	0.950(BSC)	
e1	1.800	2.000
L	0.300	0.600
θ	0°	8°

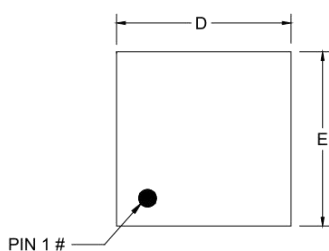
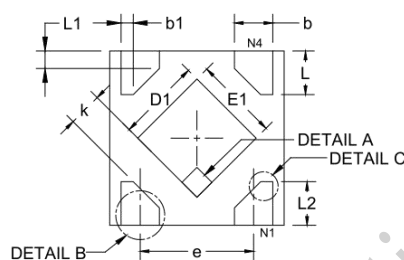
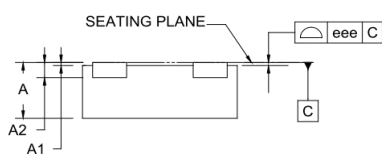
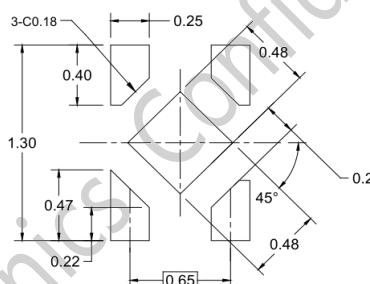
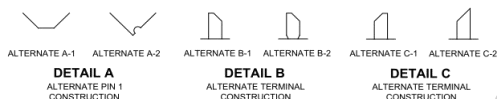

**XTDFN-1×1-4L**

**TOP VIEW**

**BOTTOM VIEW**

**SIDE VIEW**

**RECOMMENDED LAND PATTERN (Unit: mm)**

Symbol	Dimensions in Millimeters		
	Min	MOD	Max
A	0.340	0.370	0.400
A1	0.000	0.020	0.050
A2	0.100REF		
b	0.170	-	0.300
b1	0.068REF		
D	0.950	1.000	1.050
E	0.950	1.000	1.050
D1	0.430	0.480	0.530
E1	0.430	0.480	0.530
e	0.650(BSC)		
L	0.200	0.250	0.300
L1	0.093REF		
L2	0.200	-	0.370
k	0.150	-	-
eee	-	0.050	-





## REVISION HISTORY

Editions	Revised Date	Redaction person	Revision content
REV1.0	2024/10/8	PXB	First release

Developer Microelectronics Confidential

## OFFICIAL ANNOUNCEMENT

Division I will ensure the accuracy and reliability of the product specification document, but we reserve the right to independently modify the content of the specification document without prior notice to the customer. Before placing an order, customers should contact us to obtain the latest relevant information and verify that this information is complete and up-to-date. All product sales are subject to the sales terms and conditions provided by our company at the time of order confirmation.

Division I will periodically update the content of this document. Actual product parameters may vary due to differences in models or other factors. This document does not serve as any express or implied guarantee or authorization.

The product specification does not include any authorization for the intellectual property owned by our company or any third party. With respect to the information contained in this product specification, we make no explicit or implied warranties, including but not limited to the accuracy of the specification, its fitness for commercial use, suitability for specific purposes, or non-infringement of our company's or any third party's intellectual property. We also do not assume any responsibility for any incidental or consequential losses related to this specification document and its use.

We do not assume any obligations regarding application assistance or customer product design. Customers are responsible for their own use of our company's products and applications. In order to minimize risks associated with customer products and applications, customers should provide thorough design and operational safety validation.

The reproduction, transmission or use of this document or its contents is not permitted without express written authority. Once discovered, the company will pursue its legal responsibility according to law and compensate for all losses caused to the company.

Please note that the product is used within the conditions described in this document, paying particular attention to the absolute maximum rating, operating voltage range, and electrical characteristics. The Company shall not be liable for any damage caused by malfunctions, accidents, etc. caused by the use of the product outside the conditions stated in this document.

Division I has been committed to improving the quality and reliability of products, but all semiconductor products have a certain probability of failure, which may lead to some personal accidents, fire accidents, etc. When designing products, pay full attention to redundancy design and adopt safety indicators, so as to avoid accidents.

When using our chips to produce products, Division I shall not be liable for any patent dispute arising from the use of the chip in the product, the specification of the product, or the country of import, etc., in the event of a patent dispute over the products including the chip.